



SPECIFICATION



RATING	:	(A) - (1) (2)	16A 125/ 250VAC T105
		(B) - (3) (4)	16A 250V- T125
			16(6)A 250V- T125

INSULATION RESISTANCE	:	DC 500V 100MΩ OR MORE
CONTACT RESISTANCE	:	DC 2-4V 1A 30mΩ OR LESS
WITHSTAND VOLTAGE	:	AC 1500V FOR 1 Min
AMBIENT TEMPERATURE	:	0°C TO 125°C
ELECTRICAL LIFE	:	10,000 CYCLES

2121 SERIES

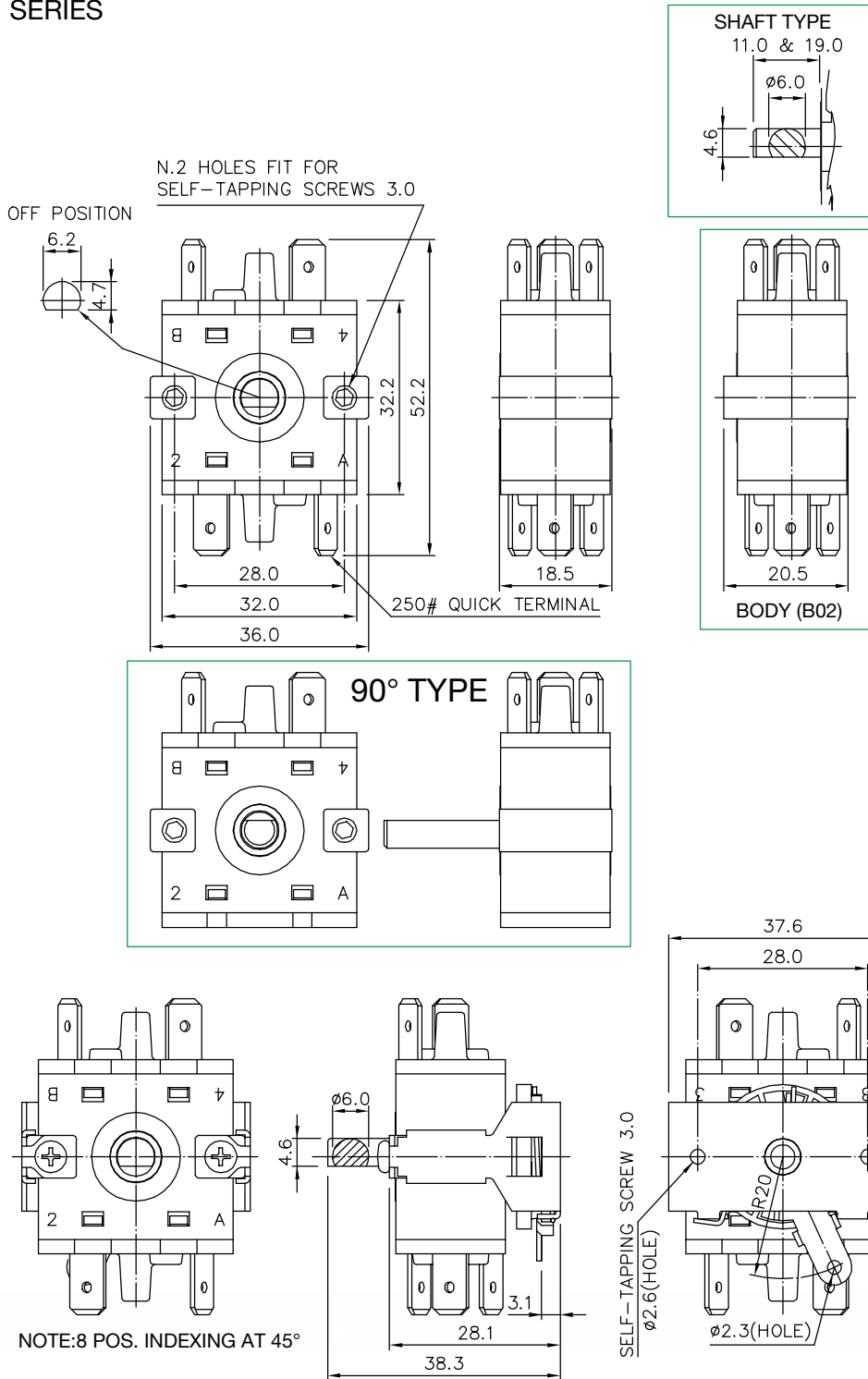

2121 CIRCUIT 1/2

*:未開發

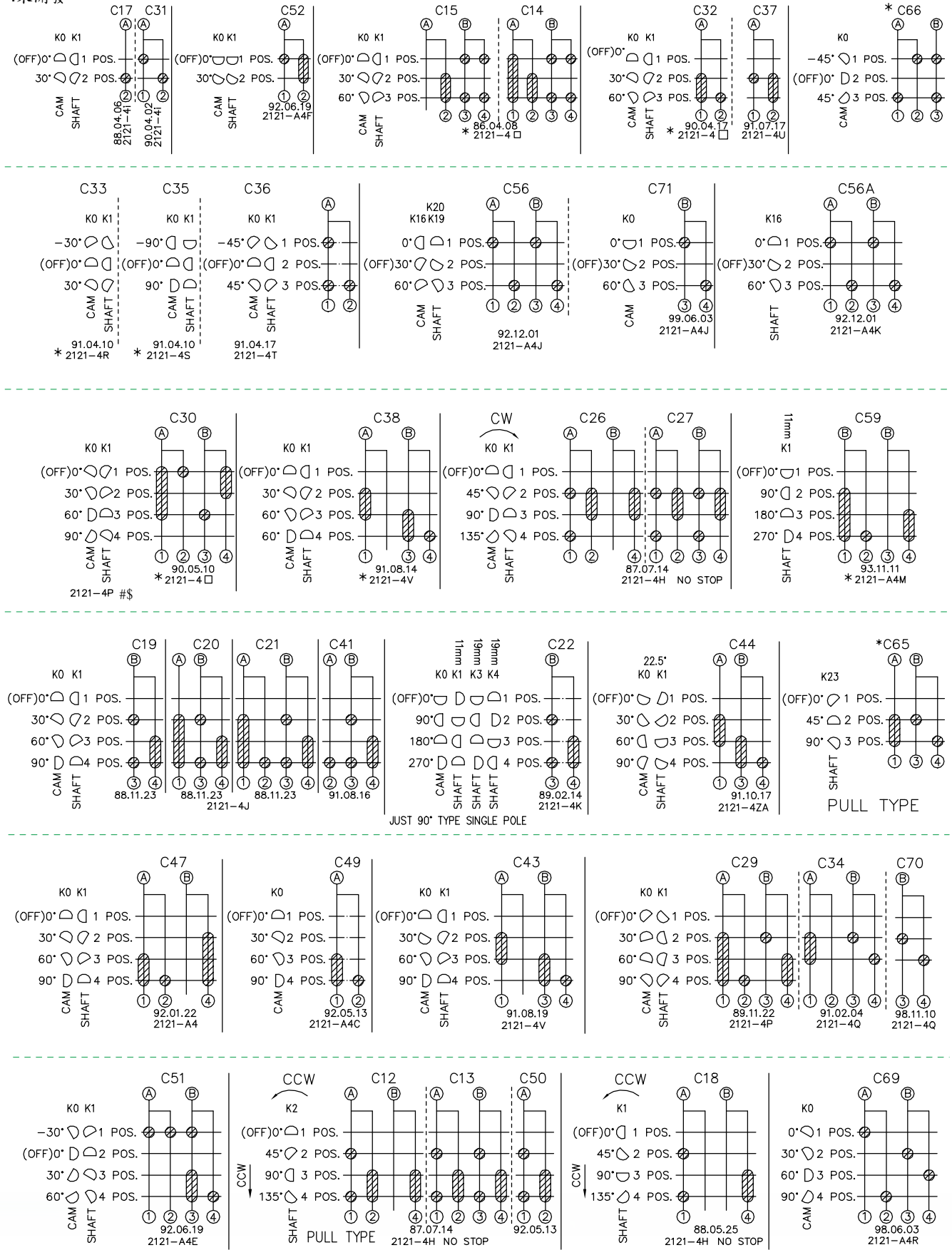

2121 CIRCUIT 2/2

*:未開發

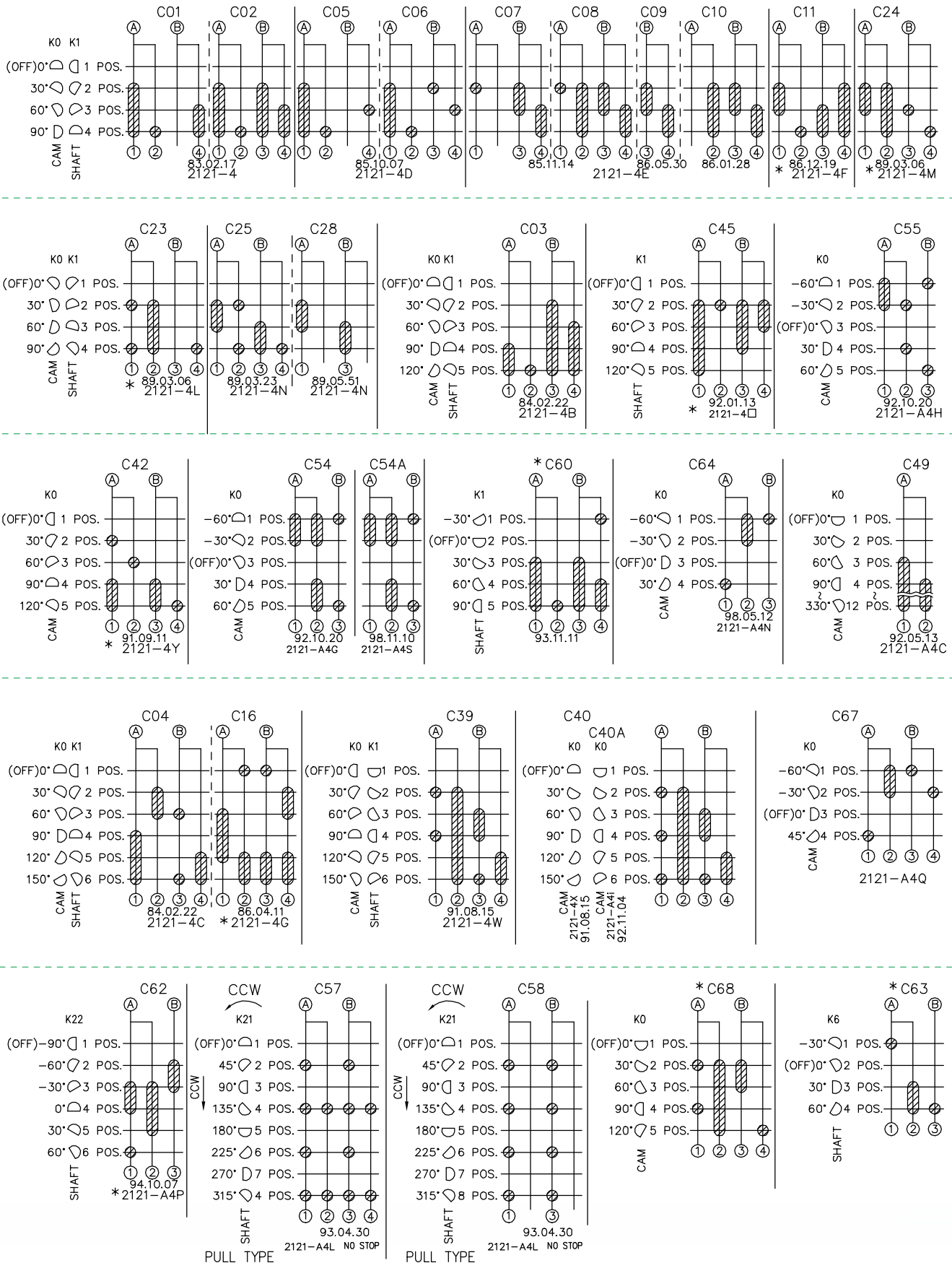

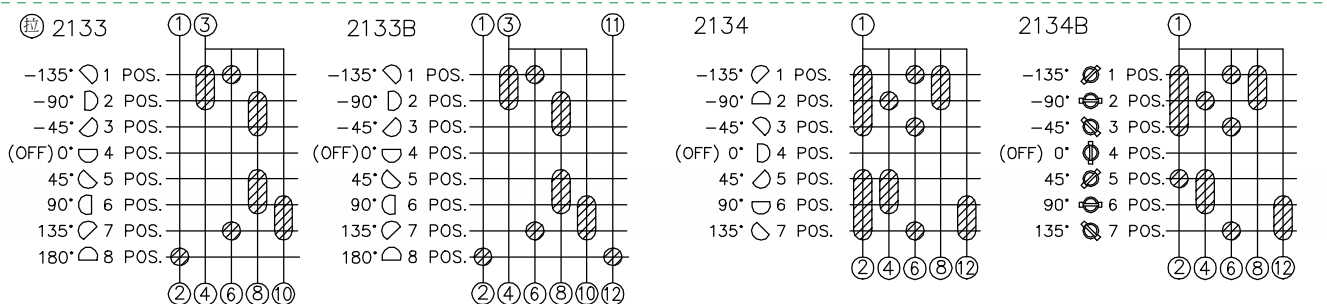
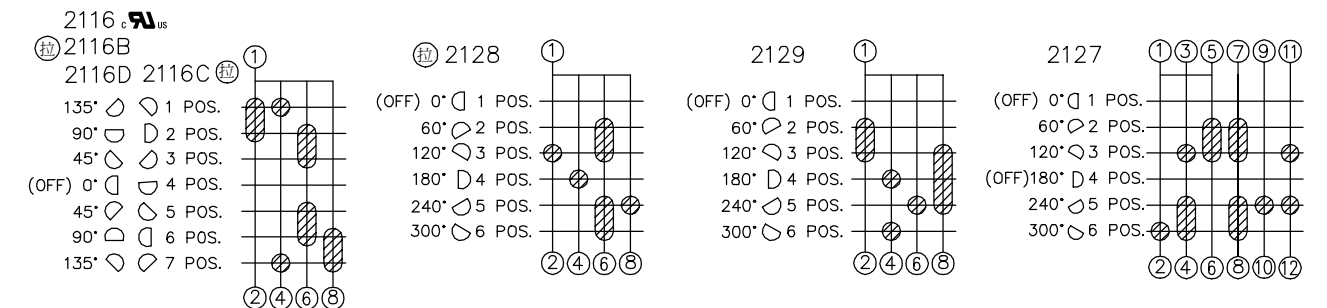
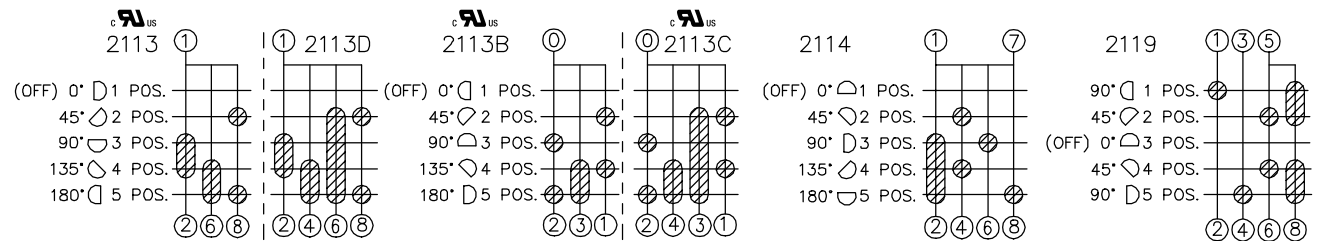
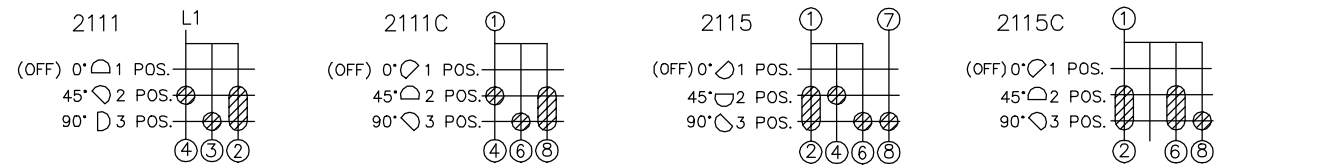
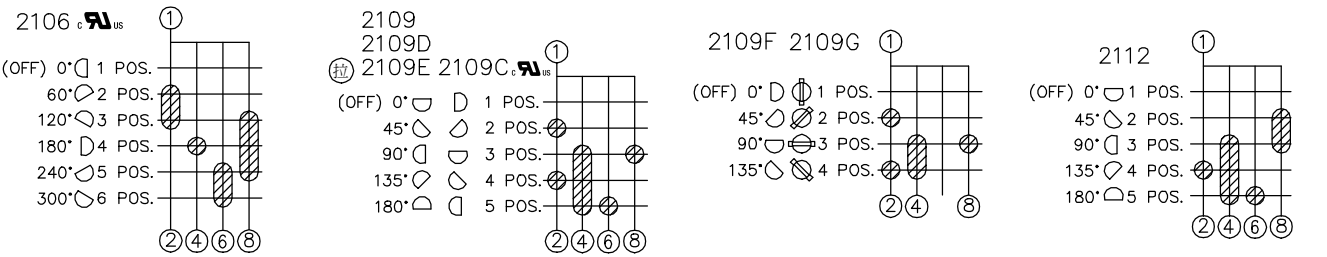
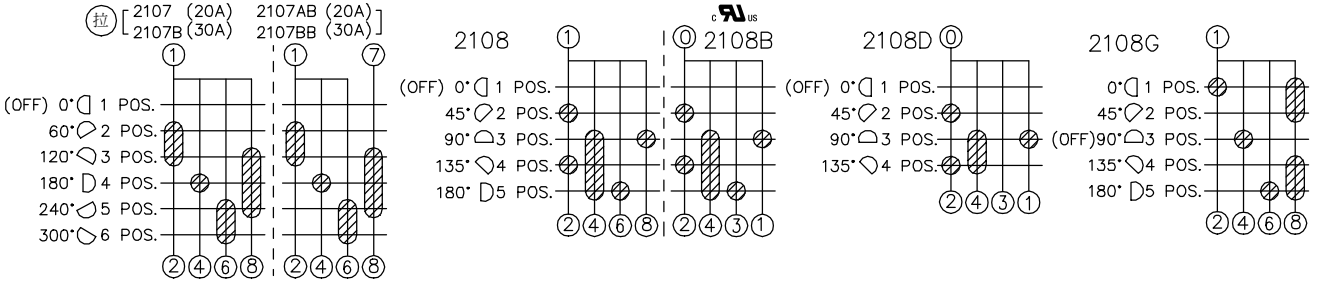
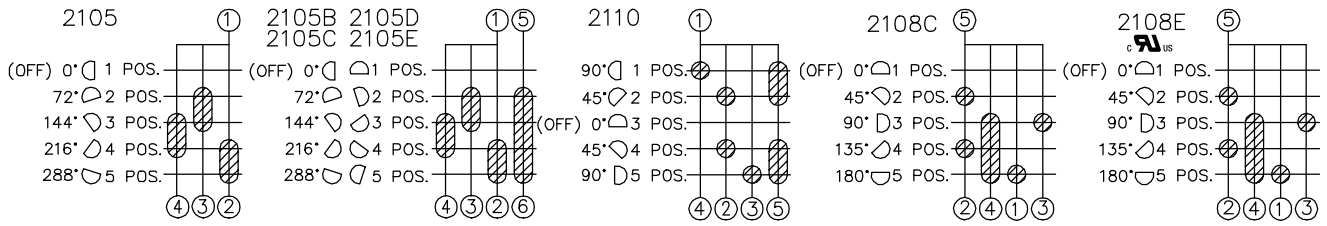

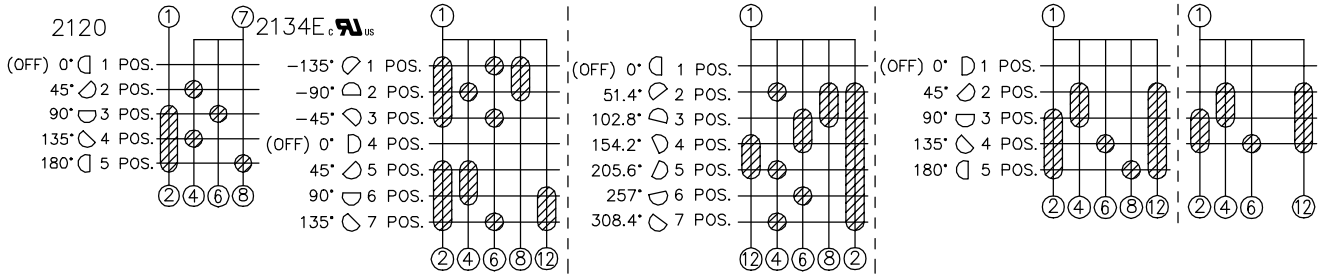

2141

2141B **c_{us}**

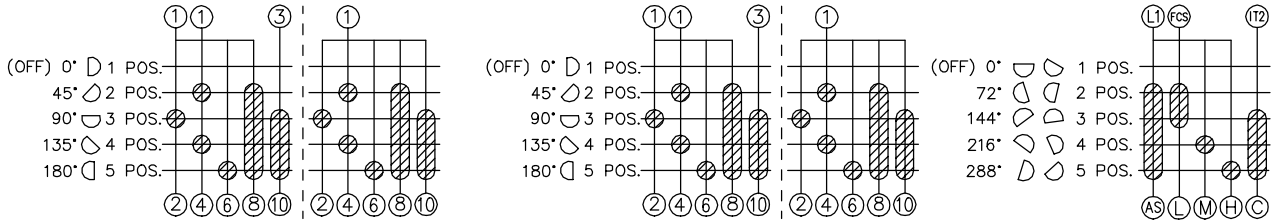

2141B **c_{us}**

2145

2145

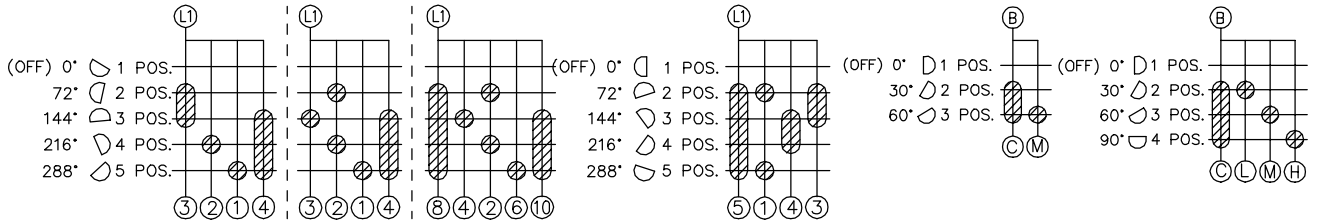

2135

2135

2136

2137

2142

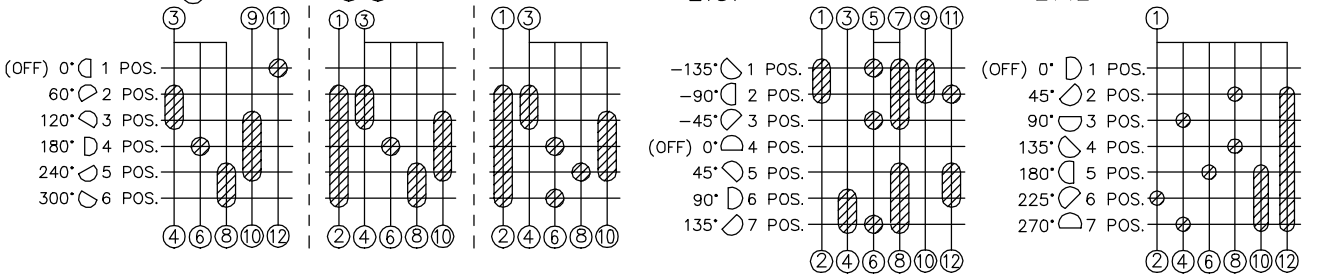

2146

2148

